

Technical specification sheet

PA 18 H 2 | Hand Pump

Specifications		
article number		100.142.035
short description		Hand Pump
model		PA 18 H 2
max. working pressure	psi	10443
capacity oil tank (effective)	oz	60.9
capacity oil tank	oz	67.3
number of stages		2
first stage output (per stroke)	oz	1.45
second stage output (per stroke)	oz	0.10
first stage pressure range	psi	0 - 653
second stage pressure range	psi	653 - 10443
max. operating force	lb	77.2
connection		3/8" NPT female
operator type		hand
double acting optional		yes
weight, ready for use	lb	16.8

Technical drawing dimensions		
dimension A	in	27.6
dimension B	in	6.7
dimension C	in	6.9

Accessories		
Double Acting Valve VM 43 L		100.182.175
Pressure Gauge Set Ø 60 - VM 43 L Valve		100.182.216

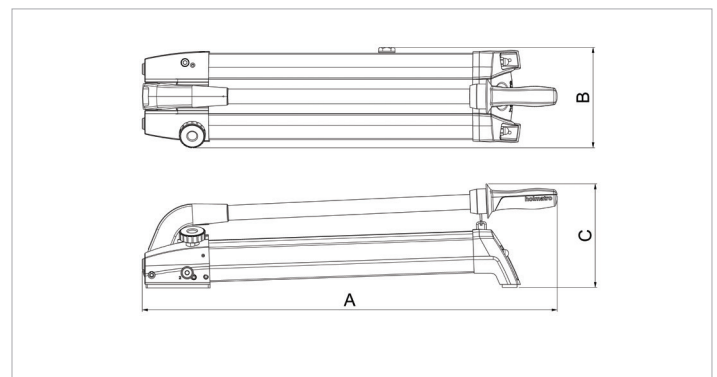

holmatro.com

© Holmatro 2024-04-15

While the greatest care has been devoted to the content, it is possible that the information in this printed matter is incorrect or incomplete. Holmatro B.V. and its affiliated companies (hereafter: Holmatro) cannot be held liable in any way for the consequences of activities undertaken on the basis of this printed matter. Values can vary within the manufacturer measurements. If you have any doubts about the correctness or completeness of the information, you shall contact Holmatro (T +31 (0)162-751480). Nothing from this printed matter can be copied and/or made public in any way without the explicit authorisation of Holmatro.